

ITP160x50-Ø20 flat

EAN 4031582070323

Hjulfælg: Aluminium, Hjulbane: Polyuretan, DIN-kugleleje

Tekniske data

Hjul-Ø	160 mm
Hjulbanebredde	50 mm
Boring-Ø	20 mm
Navlængde	60 mm
Temperaturinterval	- 20 / + 60 °C
Afprøvet efter norm	EN 12532
Egenvægt	1.1 kg
Hjulbane hårdhed	Shore A 92
Belastning (dynamisk)	800 kg
Belastning (statisk)	1600 kg

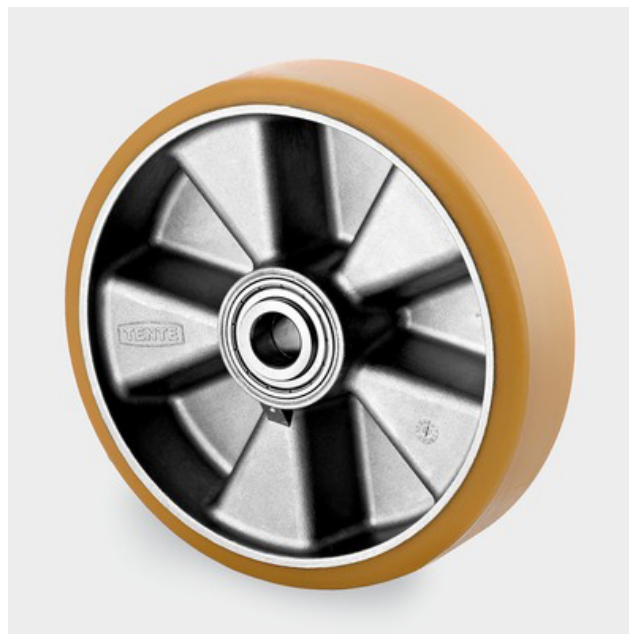

Rulle modstand	+	+	+	+	+
Kørselsstøj	+	+	+	+	+
Slid	+	+	+	+	+
Rustbeskyttelse	+	+	+	+	+

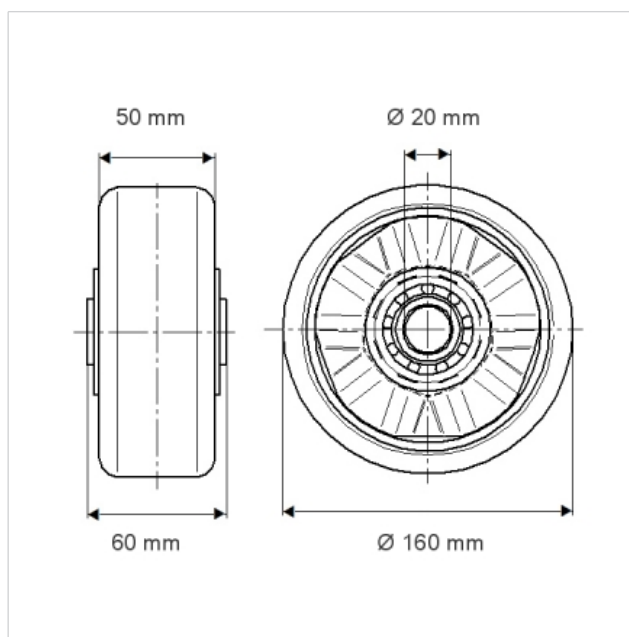



ITP160x50-Ø20 flat

EAN 4031582070323

