

ITP125x50-Ø20 flat

EAN 4031582070316

Hjulfælg: Aluminium, Hjulbane: Polyuretan, DIN-kugleleje

Tekniske data

Hjul-Ø	125 mm
Hjulbanebredde	50 mm
Boring-Ø	20 mm
Navlængde	60 mm
Temperaturinterval	- 20 / + 60 °C
Afprøvet efter norm	EN 12532
Egenvægt	0.804 kg
Hjulbane hårdhed	Shore A 92
Belastning (dynamisk)	500 kg
Belastning (statisk)	1000 kg

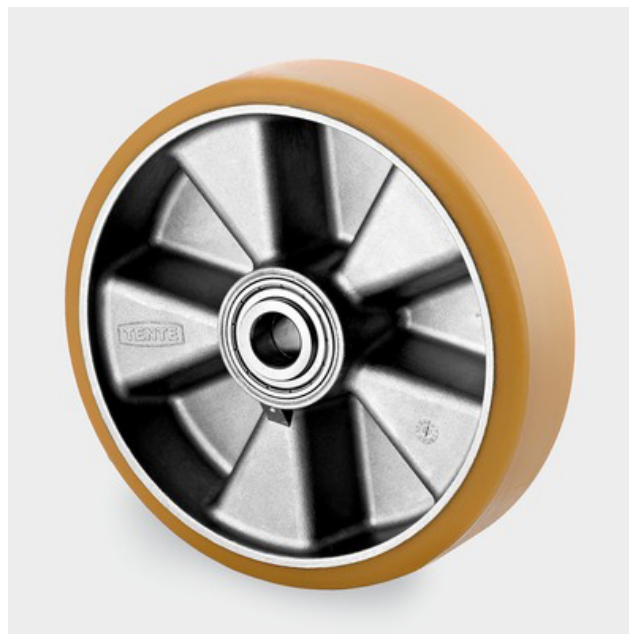

Rulle modstand	+	+	+	+	+
Kørselsstøj	+	+	+	+	+
Slid	+	+	+	+	+
Rustbeskyttelse	+	+	+	+	+

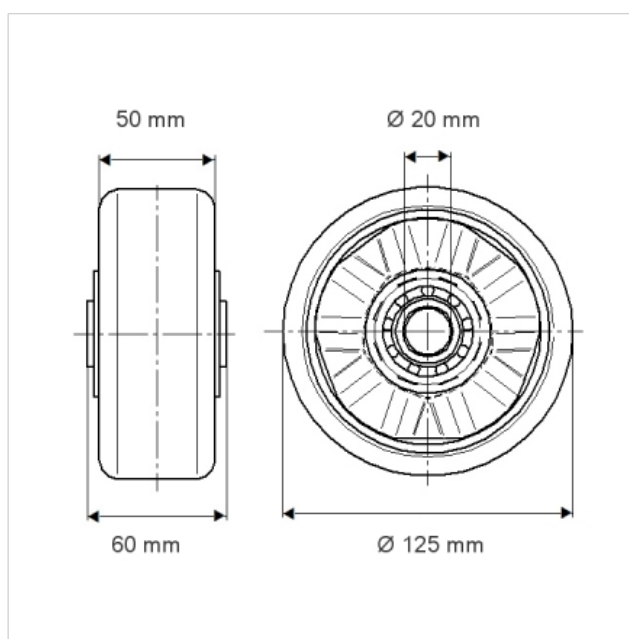

ITP125x50-Ø20 flat

EAN 4031582070316

