

# ZETA

## 4688ITP125P63 Flat

EAN 4031582030501

Faste hjul, Gaffel af kraftig presset stålplade, forstærket, gul-kromatiseret, hjul boltet i gaffel, befæstigelsesplade.

Hjulfælg: Aluminium, Hjulbane: Polyuretan, DIN-kugleleje



BETTER MOBILITY. BETTER LIFE.



Billedet kan afvige fra originalt produkt

### Tekniske data

Hjul-Ø	125 mm
Bredde af hjulbane	50 mm
Plademål	137 x 117 mm
Hulafstand	105 x 80/75 mm
Pladehul-Ø	11 mm
Byggehøjde	164 mm
Temperaturinterval	- 20 / + 60 °C
Standard	EN 12532
Vægt	1.759 kg
Hjulbane hårdhed	Shore A 92
Belastning (dynamisk)	500 kg
Belastning (statisk)	1000 kg

### Dimensioner

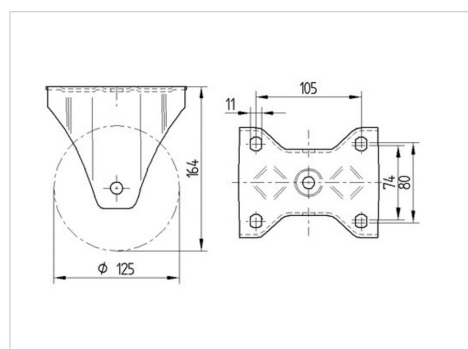

### Egenskaber/fordele

Rullemodstand	● ● ● ○ ○
Kørselsstøj	● ● ● ○ ○
Slid	● ● ● ● ○
Rustbeskyttelse	● ● ● ○ ○

# ZETA

4688ITP125P63 Flat

EAN 4031582030501



BETTER MOBILITY. BETTER LIFE.

## Struktur og montering

